

ANG Panel Meter Housings Product Drawings

ROSE+BOPLA ENCLOSURES

7330 Executive Way
Frederick, MD 21704
301-696-9800
www.Rose-Bopla.com
rbinfo@pm-usa.com
Last Updated 4/13/2009



TECHNICAL DATA:

- Color—Black Powdercoat
- Material—Extruded Aluminum
- Protection Classifications:
NEMA 4X
IP 66, DIN 40050

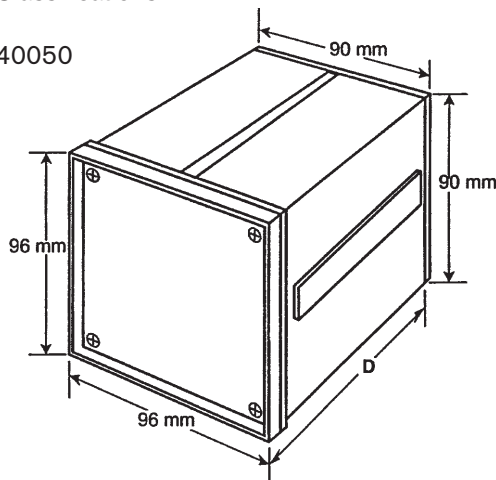

Assembly Instructions

Housings conform to DIN 43700. Install in a panel cut-out with dimensions of 92 x 92mm + .8mm. Remove mounting bars. Insert in panel cut-out. Install mounting bars. Tighten mounting bars with set screws to secure housing in panel.

Rose+Bopla's ANG Panel Meter Housing offers NEMA 4X protection. This 1/4 DIN housing body is a hollow extrusion of heavy duty aluminum for maximum integrity with

ANG Panel Meter Housings

internal slotting to accommodate printed circuit boards or chassis. Gasketed, cast aluminum front and rear lids provide maximum protection. External mounting bars provide secure panel mounting in 2 or 4 positions.

ANG Panel Meter Housings offer easy maintenance benefits. The front bezel and rear lid can be taken off without removing the housing from the panel. These housings fit into pre-existing panels. Standard depths of 109.5mm and 165.5mm are available off-the-shelf in black. Custom lengths and colors can be turned around in 2 weeks or less.

ANG Panel Meter Housing comes complete with, enclosure body, mounting profiles, bezel, front frame, rear lid, 1.5 allen key, adhesive plate, screws and washers.

ANG Panel Meter Housings				
Part #	Length	Width	Height	Weight
ANG 9610	4.31/109.5	3.77/96	3.77/96	1.44 lbs.
ANG 9616	6.51/165.5	3.77/96	3.77/96	1.64 lbs.
ANG 9601	Sold in 1 meter lengths for custom sizes.			8.0 lbs.

Note: Dimensions are external. Metric is the primary dimension. Inch conversions are for the user's convenience and are for reference only.

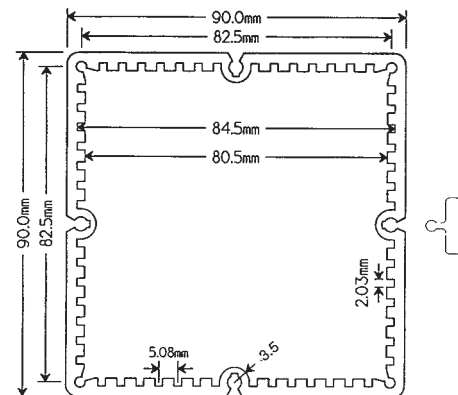

Enclosure Profile



Ang Housing

ANG 9610, ANG 9616, ANG 9601

External Dimensions: W 96 x H 96 mm

Standard Features

- **ANG 9610** Panel Meter Housing includes: enclosure body, mounting profiles, bezel, front frame, rear lid, 1.5 allen key, adhesive plate, screws and washers. L109.5 x W96 x H96 mm.
- **ANG 9616** Panel Meter Housing includes: enclosure body, mounting profiles, bezel, front frame, rear lid, 1.5 allen key, adhesive plate, screws and washers. L165.5 x W96 x H96 mm.
- **ANG 9601** Closed aluminum extrusion, sold in meter lengths. L1000 x W90 x H90 mm.

Accessories

- **ANG 96 MPI** Aluminum Mounting Panel.
- **ANG 96 BZ** Front Bezel
- **ANG 96 FF** Front Open Frame
- **ANG 96 RL** Rear Cover
- **0202002** Replacement Lid Screws (8 required)

Housing Profile and Mounting Bar Dimensions

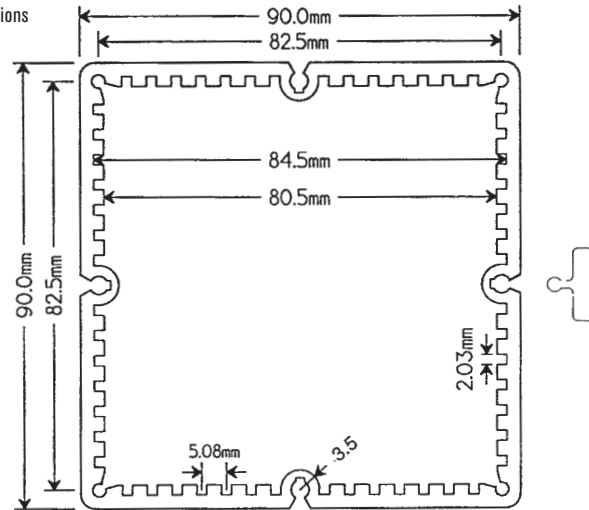

Front Bezel Dimensions/ANG 96 BZ

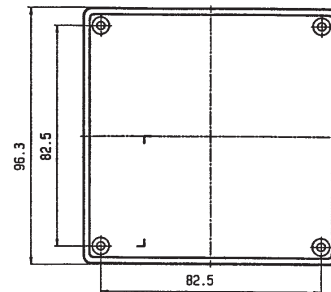
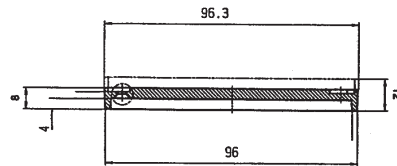

Front Open Frame Dimensions/ANG 96 FF

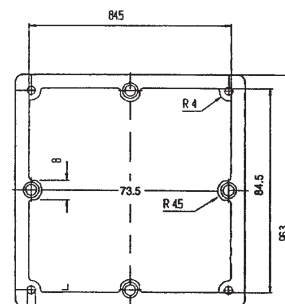
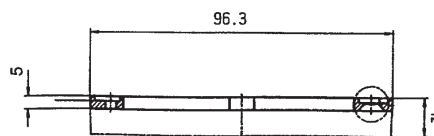

Rear Cover Dimensions/ANG 96 RL

