

# Future Keyboard & Sloped Housings

Keyboard and Sloped Housing System



For Finishing Services, Product Support, or to Order

Call 1-301-696-9800

# Futura Keyboard and Sloped Housings



These flat control or keypad enclosures were designed especially for EDP workplaces and according to ergonomic guidelines.

In these product series you will find enclosures with a ball-of-the-thumb rest or with a tilting display area for optimal legibility. In addition, there are designs in which the half-shells are fitted either as a console type or in parallel with the top shell inverted. Almost all these enclosures are suitable for fitting with a mechanical keypad or a display, and for the

flush-fitting of a membrane keypad. Some of the keypad panels can be supplied with either a closed or open rear wall.

The aluminium panels which are supplied as standard with the open versions can easily be processed mechanically, and provide sufficient space for different types of connectors or sub-D sockets.

A number of mounting bosses for accepting PCBs or mounting plates are incorporated in the lids and bases.

**Enclosure material:** ABS.

For technical data see pages 646-650.

















**Colour:**

Light grey, similar to RAL 7035;  
T 900 black, similar to RAL 9005;  
special colours on request.

**Scope of delivery:**

Lid and base, fixing screws, RO versions with aluminium front panel, 4 rubber feet.

**Ingress protection:** IP 40/DIN EN 60529.

Enclosures		External dimensions				Design	
Model	Order no.	L	W	H (console)	H (parallel)	Console-type	Parallel
T 888 F	47888200	195	275	24.5 / 48	36.3		
T 889 F	47889200	170	132	24.5 / 44.9	36.3		
T 898	47898000	195	151	24.5 / 44.9	36.3		
T 898 F	47898200	195	151	24.5 / 44.9	36.3		
T 898 RO	47898100	195	151	24.5 / 44.9			
T 898 F-RO	47898300	195	151	24.5 / 44.9			
T 899	47899001	125	150	15 / 30.7	22.8		
T 890	47890001	300	225	17 / 48.7			
T 893	47893001	500	225	17 / 48.7			
T 895 P	47895101	480	330	89.3			
T 900	47900000	280	240	33			



# Futura Keyboard and Sloped Housings



Model T 888 F  
 Membrane keypad area 253.1 x 175.3 mm with recess 1 mm deeper.  
 Ingress protection: IP 40 (IP 54 available on request).  
 The enclosure parts can be placed on top of each other in **console form** or also **parallel**, as required.

## Futura Model T 888 F

Order designation		External dimensions			
Model	Order no.	L	W	H (console)	H (parallel)
T 888 F	47888200	195	275	24.5 / 48	36.3

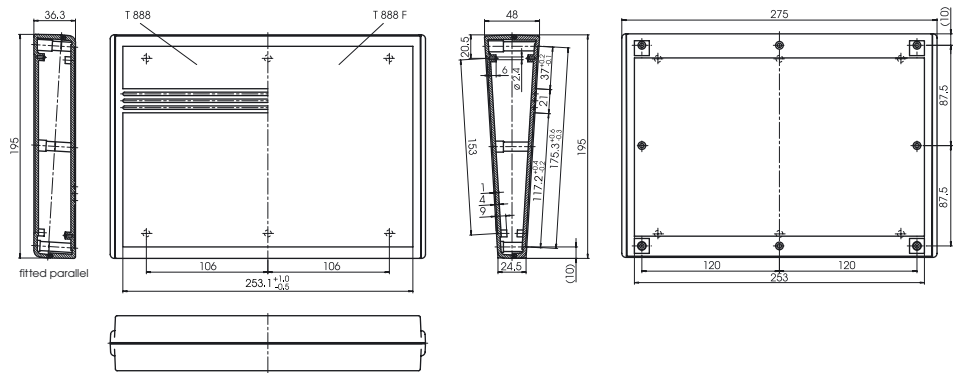

Z-2301143



Model T 889 F  
 Membrane keypad area 110.1 x 150.2 mm with recess 1 mm deeper.  
 Ingress protection: IP 40 (higher protection category IP 54 available on request).  
 The enclosure parts can be placed on top of each other in **console form** or also **parallel**, as required.

## Futura Model T 889 F

Order designation		External dimensions			
Model	Order no.	L	W	H (console)	H (parallel)
T 889 F	47889200	170	132	24.5 / 44.9	36.3

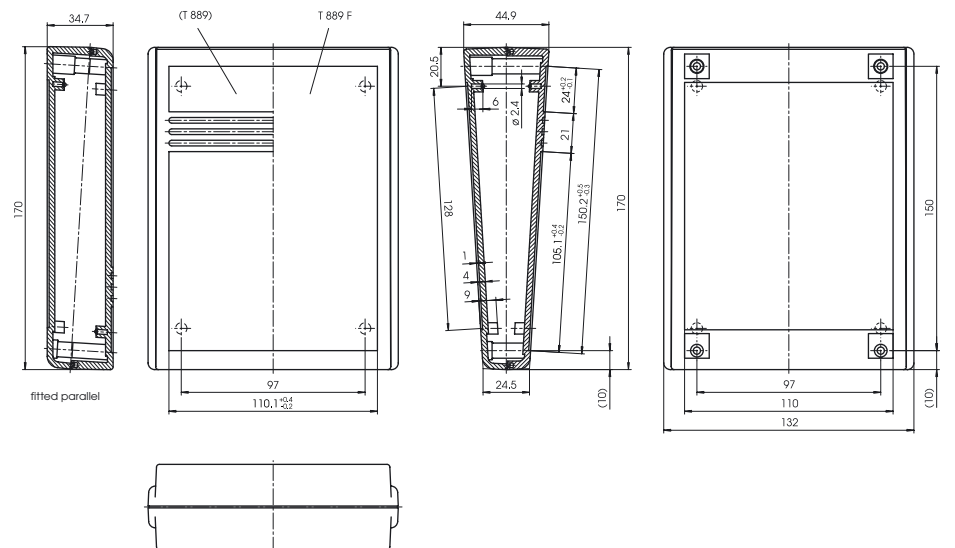

Z-2301145

## Futura Model T 898 / T 898 F

Order designation		External dimensions				Description
Model	Order no.	L	W	H (cons.)	H (parallel)	
T 898	47898000	195	151	25.2 / 48	36.3	Split key area
T 898 F	47898200	195	151	25.2 / 48	36.3	Continuous key area

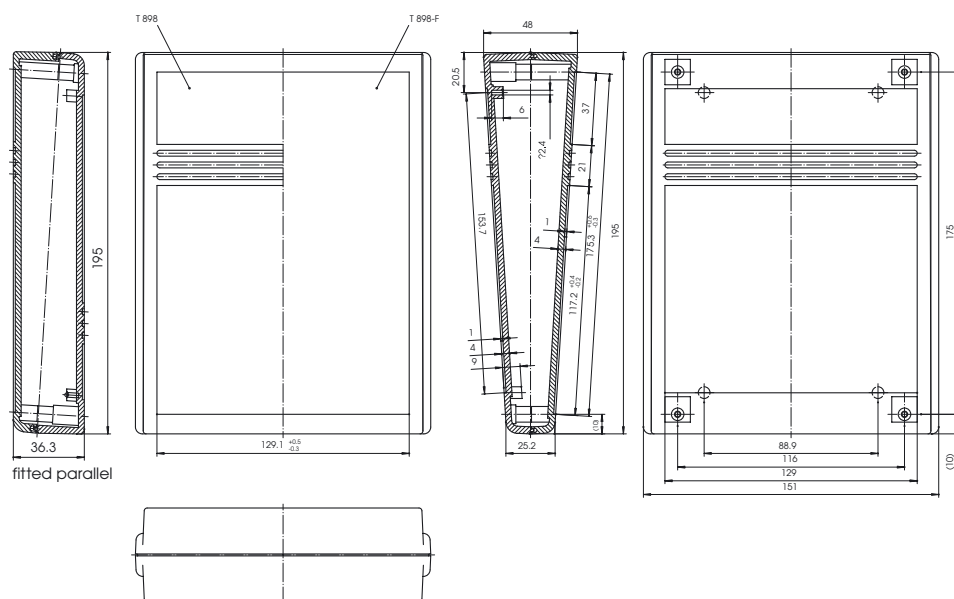

Z-2300662

## Futura Model T 898 RO / T 898 F-RO

Order designation		External dimensions				Description
Model	Order no.	L	W	H (cons.)	H (parallel)	
T 898 RO	47898100	195	151	25.2 / 49	36.3	Rear wall open, split key area
T 898 F-RO	47898300	195	151	25.2 / 49	36.3	Rear wall open, continuous key area

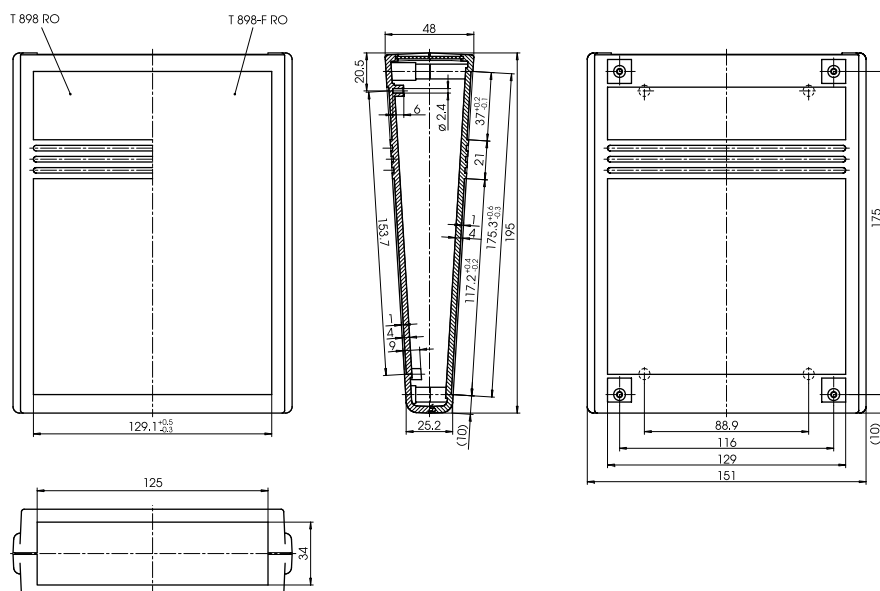

Z-2300661



Model T 898 / T 898 F  
 Membrane keypad area 129.1 x 175.3 mm with recess 1 mm deeper.  
 Ingress protection: IP 40 (IP 54 available on request).  
 The base includes mounting bosses for Euro cards. The enclosure parts can be placed on top of each other in **console form** or also **parallel**, as required.



Model T 898 RO / T 898 F-RO  
 Membrane keypad area 129.1 x 175.3 mm with recess 1 mm deeper.  
 Ingress protection: IP 40.  
 The base includes mounting bosses for Euro cards. The scope of delivery comprises an anodized plug-in aluminium rear panel (1 mm thick).



# Futura Keyboard and Sloped Housings



### Model T 899

Attractively designed small hand-held or desktop enclosure:

- membrane keypad area 100.15 x 80.1 mm with recess 1 mm deeper
  - installation of a display is possible
- Ingress protection: IP 54

### Futura Model T 899

Order designation		External dimensions			
Model	Order no.	L	W	H (console)	H (parallel)
T 899	47899001	125	150	15 / 30.7	22.8

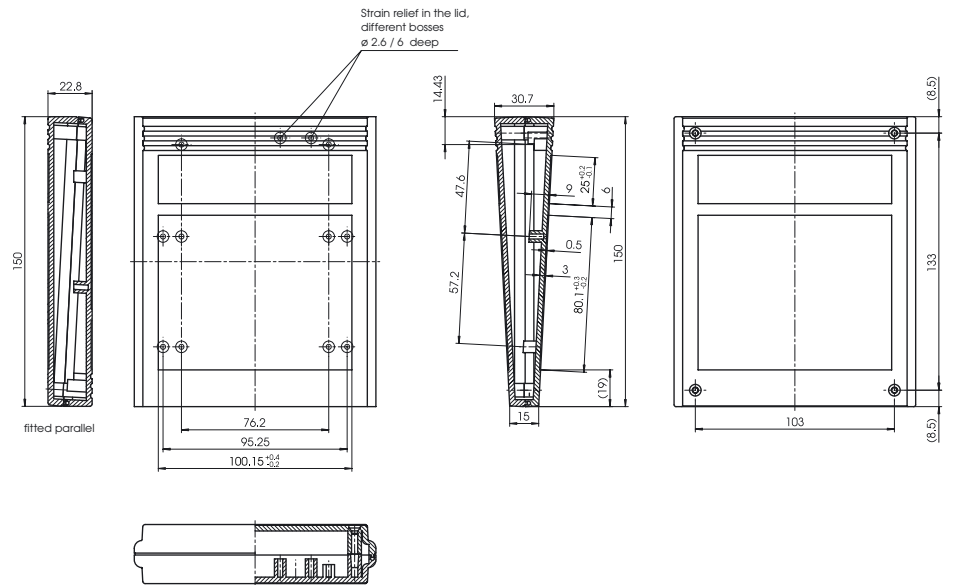

### Futura Model T 890 / T 893

Order designation		External dimensions		
Model	Order no.	L	W	H (console)
T 890	47890001	300	225	17 / 48.5
T 893	47893001	500	225	17 / 48.5

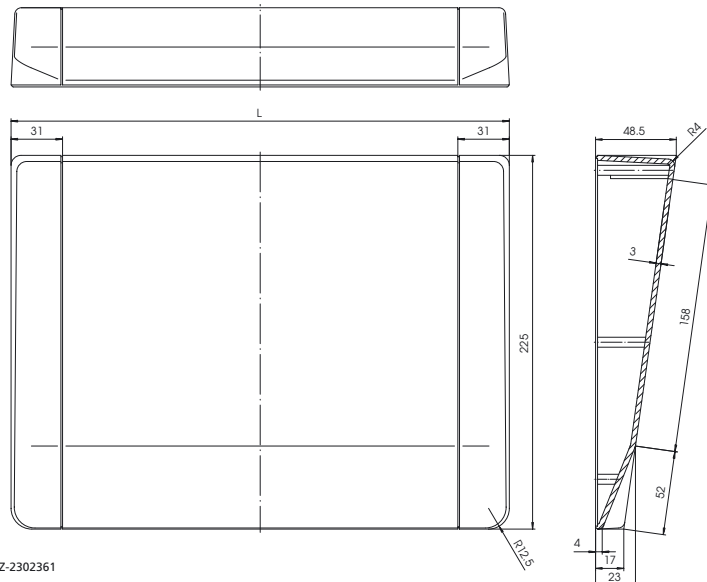

### Model T 890 / T 893

The first keypad enclosure with moulded-on ball-of-the-thumb rest. This ensures that the installation of raised keypads satisfies the ergonomic guidelines.

The curved side units highlight the attractiveness of this high-value series of enclosures.

Material: ABS lid, sheet steel base.

Ingress protection: IP 40

