



ROSE+BOPLA
ENCLOSURES

A PHOENIX MECANO COMPANY

Executive Plug Housings Product Drawings Last Updated 7/8/2008

Rose+Bopla Enclosures
7330 Executive Way
Frederick, MD 21704
301-696-9800
www.rose-bopla.com
rbinfo@pm-usa.com

Dimensional Drawings

For Secondary Services, Product Support, or To Order, Call 1-301-696-9800



Executive plug housings are available in many different styles for use in specific countries. Choosing from 5 lids with a socket, 3 lids without a socket, and 2 console-type lids, along with 3 bases

Executive Plug Housings

with a plug and one base without a plug—it is possible to create 32 unique enclosures. Console lid versions are available with an opening to incorporate display applications, or with a large membrane keypad area.

All enclosures are made of a flame-resistant Polycarbonate/ABS blend plastic, meet ingress protection category IP 40, and have been tested to VDE 0624/IEC 884. Mounting bosses for self-tapping screws are molded into the base and, in some models, in the lid. These bosses ensure easy assembly. Depending on your specific application design needs, the installation area, and the desired operating position, the plug housing lid can also be attached at a 180° angle for optimal use.

An Executive plug housing includes a lid, base, and assembly screws, including pin/socket inserts, depending on type.

TECHNICAL DATA:

- Color: Lid, light gray, similar to RAL 7035; base, agate gray, similar to RAL 7038. Special colors on request. Minimum quantities may apply.
- Material: Polycarbonate/ABS blend plastic
- Ingress Protection: IP 40/DIN VDE 0470
- Flammability: UL 94 VO/1.6
- Testing: Tested to VDE 0624/IEC 884.
- Subject to minimum order quantities.

Executive Plug Housings				
Model Number	Part Number	Description	Weight lbs.	Drawing Page #
ESO 1250 E	44010004	Lid with plug per DIN 49440/CEE 7111	.423	17-286
ESO 1250 CEE	44020004	Lid with plug per CEE 7 V	.430	17-286
ESO 1250 SEV	44030004	Lid with plug per SEV 1011S.24508	.421	17-286
ESO 1230	44060004	Lid without plug	.282	17-286
ESO 1240	44050004	Lid without plug	.322	17-286
ESO 1250	44040004	Lid without plug	.357	17-286
ESO 1240 P	44070004	Sloped lid without plug, without display opening	.318	17-286
ESO 1240 PD	44080004	Sloped lid without plug, with display opening	.304	17-286
ESU 1200 E/CEE	44093004	Base with plug per DIN 49441R2/CEE 7 VIII	.168	17-286
ESU 1200 SEV	44091004	Base with plug per SEV 1001.524508	.119	17-286
ESU 1250 EUS	44092004	Base with plug per UL 498.ANSI ST. A-15	-	17-286
ESU 1200	44090004	Base without plug	.117	17-286

E =German version with ground

ECEE =German/French with ground

CEE =French version with ground

EUS =US version with ground

SEV =Swiss version with ground















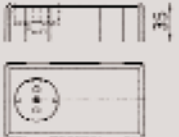

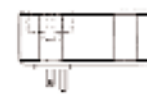



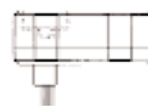
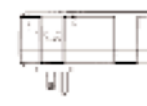
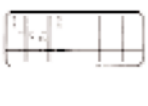

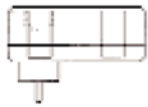
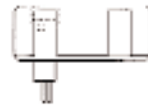
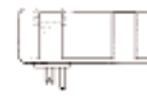
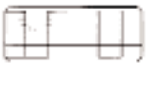

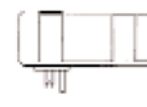

Accessories shown on drawing page.

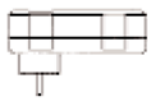
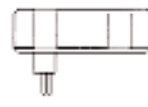
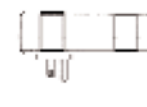
Note: Dimensions are external. Metric is the primary dimension.

Inch conversions are for the user's convenience and are for reference only.

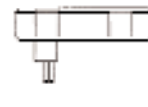
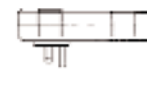

◀
 Left: ESU 1200 E-US base with ESO 1230 lid;
 Middle: ESU 1200 SEV base with ESO 1250 SEV lid;
 Right: ESU 1200 E/CEE base with ESO 1240 P lid.

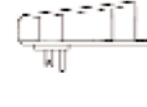
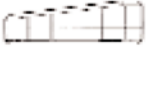
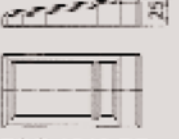
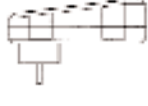
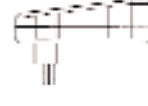
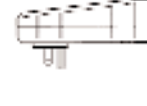
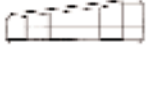
Possible Configurations	BASES			
				
LIDS	ESU 1200 E/CEE	ESU 1200 SEV	ESU 1250 E-US	ESU 1200
 ESU 1250 E				
 ESU 1250 CEE				
 ESU 1250 SEV				
 ESU 1250				
 ESU 1240				
 ESU 1230				
 ESU 1240 P				
 ESU 1240 PD				

Plug Housings

Executive Plug Housings

Standard Features

- Subject to minimum quantity order
- ESO 1250 E/44010004 Lid with plug per DIN 49440/CEE 7111
 - ESO 1250 CEE/44020004 Lid with plug per CEE 7V
 - ESO 1250 SEV/44030004 Lid with plug per SEV 1011S.24508
 - ESO 1230/44060004 Lid without plug
 - ESO 1240/44070004 Lid without plug
 - ESO 1250/44040004 Lid without plug
 - ESO 1240 P/44070004 Sloped lid without plug, without display opening
 - ESO 1240 PD/44080004 Sloped lid without plug, with display opening
 - ESU 1200 E/CEE/44093004 Base with plug per DIN 49441R2/CEE 7 VII
 - ESU 1200 SEV/44091004 Base with plug per SEV 1001.524508
 - ESO 1250 E-US/44092004 Base with plug per UL 498,ANSI ST. A-15
 - ESU 1200/44090004 Base without plug

Console Lids ESO 1240 P / PD

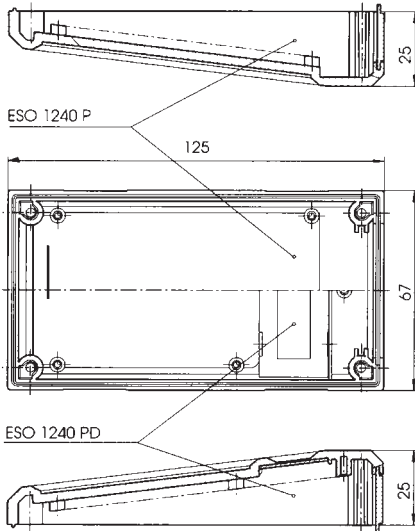

Bases ESU 1200 . .

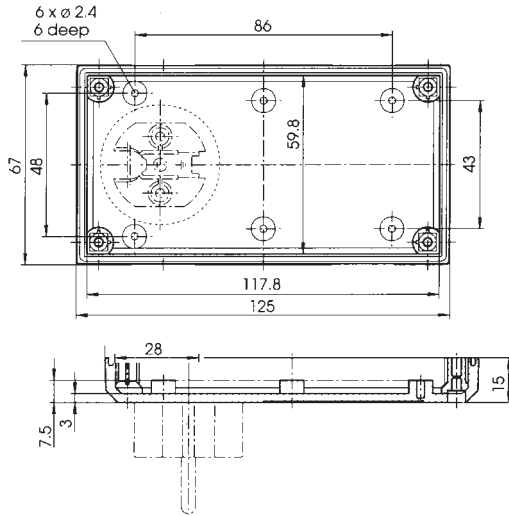

Lids with Sockets ESO 1250 . .

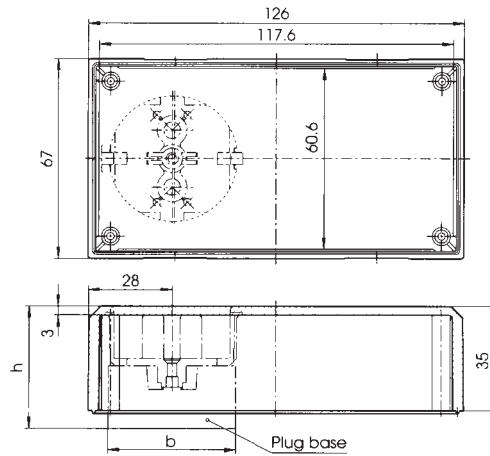

Model Number	Part Number	b	h
ESO 1250 E	44010004	45	41
ESO 1250 CEE	44020004	42	38
ESO 1250 SEV	44030004	37	41

Lids without Sockets ESO 12 . .

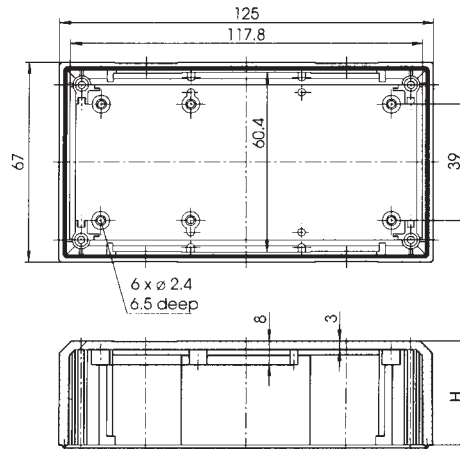

Model #	Part #	h
ESO 1250	44040004	35
ESO 1240	44050004	25
ESO 1230	44060004	15